

CYLINDRE EUROPÉEN NORMAL

SÉRIE 101L (5982) PANNETON LONG

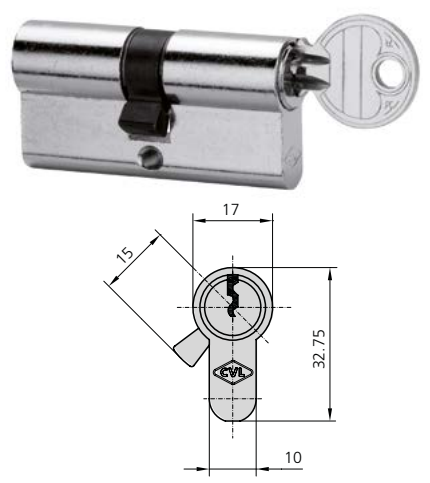

CARACTÉRISTIQUES

- Cylindre Européen à cle plate et 5 goupilles
- Corp et rotor en laiton
- Goupilles en inox
- Panneton long de 15mm
- Finition en laiton et nickel
- 3 clés
- Dimensions de 40 à 160mm

ACCESSOIRES EN OPTION



DESCRIPTION	RÉF.	DIMENSIONS			FINITIONS	PIÈCES
		A	B	C		
• Cylindre double	101L3030/3	31	31	62	LP	1
	101L3030/4	31	31	62	LN	1
	101L3035/3	31	36	67	LP	1
	101L3035/4	31	36	67	LN	1
	101L3040/3	31	41	72	LP	1
	101L3040/4	31	41	72	LN	1
	101L3535/3	36	36	72	LP	1
	101L3535/4	36	36	72	LN	1
	101L3045/3	31	46	77	LP	1
	101L3045/4	31	46	77	LN	1
	101L3540/3	36	41	77	LP	1
	101L3540/4	36	41	77	LN	1
	101L3050/3	31	51	82	LP	1
	101L3050/4	31	51	82	LN	1
	101L3545/3	36	46	82	LP	1
	101L3545/4	36	46	82	LN	1
	101L4040/3	41	41	82	LP	1
	101L4040/4	41	41	82	LN	1
	101L3055/3	31	56	87	LP	1
	101L3055/4	31	56	87	LN	1
	101L4045/3	41	46	87	LP	1
	101L4045/4	41	46	87	LN	1
	101L3550/3	36	51	87	LP	1
	101L3550/4	36	51	87	LN	1
	101L3060/3	31	61	92	LP	1
	101L3060/4	31	61	92	LN	1
	101L3555/3	36	56	92	LP	1
	101L3555/4	36	56	92	LN	1
	101L4050/3	41	51	92	LP	1
	101L4050/4	41	51	92	LN	1
	101L4545/3	46	46	92	LP	1
	101L4545/4	46	46	92	LN	1
	101L3065/3	31	66	97	LP	1
	101L3065/4	31	66	97	LN	1
	101L3560/3	36	61	97	LP	1
	101L3560/4	36	61	97	LN	1
	101L3070/3	31	71	102	LP	1
	101L3070/4	31	71	102	LN	1

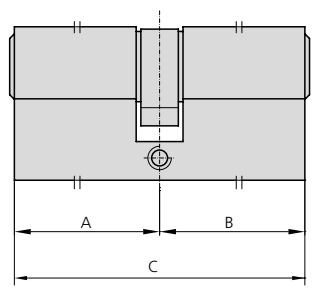

CYLINDRE EUROPÉEN NORMAL

SÉRIE 101L (5982) PANNETON LONG

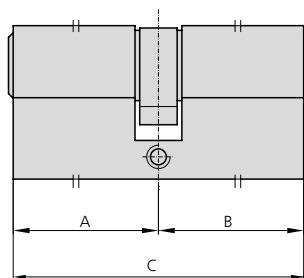

DESCRIPTION	RÉF.	DIMENSIONS			FINITIONS	PIÈCES
		A	B	C		
	101L3565/3	36	66	102	LP	1
	101L3565/4	36	66	102	LN	1
	101L4060/3	41	61	102	LP	1
	101L4060/4	41	61	102	LN	1
	101L4555/3	46	56	102	LP	1
	101L4555/4	46	56	102	LN	1
	101L5050/3	51	51	102	LP	1
	101L5050/4	51	51	102	LN	1
	101L4560/3	46	61	107	LP	1
	101L4560/4	46	61	107	LN	1
	101L3080/3	31	81	112	LP	1
	101L3080/4	31	81	112	LN	1
	101L4070/3	41	71	112	LP	1
	101L4070/4	41	71	112	LN	1
	101L4565/3	46	66	112	LP	1
	101L4565/4	46	66	112	LN	1
	101L5060/3	51	61	112	LP	1
	101L5060/4	51	61	112	LN	1
	101L5555/3	56	56	112	LP	1
	101L5555/4	56	56	112	LN	1
	101L3090/3	31	91	122	LP	1
	101L3090/4	31	91	122	LN	1
	101L3585/3	36	86	122	LP	1
	101L3585/4	36	86	122	LN	1
	101L4080/3	41	81	122	LP	1
	101L4080/4	41	81	122	LN	1
	101L4575/3	46	76	122	LP	1
	101L4575/4	46	76	122	LN	1
	101L6060/3	61	61	122	LP	1
	101L6060/4	61	61	122	LN	1
	101L30100/3	31	101	132	LP	1
	101L30100/4	31	101	132	LN	1
	101L4585/3	46	86	132	LP	1
	101L4585/4	46	86	132	LN	1
	101L6565/3	66	66	132	LP	1
	101L6565/4	66	66	132	LN	1
	101L40100/3	41	101	142	LP	1
	101L40100/4	41	101	142	LN	1
	101L7070/3	71	71	142	LP	1
	101L7070/4	71	71	142	LN	1
	101L7575/3	76	76	152	LP	1
	101L7575/4	76	76	152	LN	1
	101L8080/3	81	81	162	LP	1
	101L8080/4	81	81	162	LN	1

CYLINDRE EUROPÉEN NORMAL

SÉRIE 101L (5982) PANNETON LONG

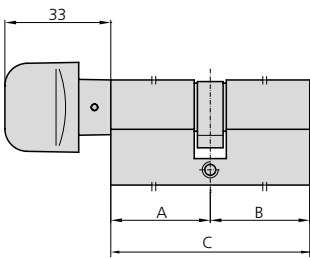
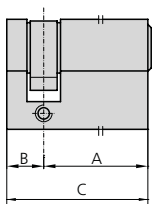
DESCRIPTION	RÉF.	DIMENSIONS			FINITIONS	PIÈCES
		A	B	C		
<ul style="list-style-type: none"> Cylindre avec bouton 	101LPM3030/3	31	31	62	LP	1
	101LPM3030/4	31	31	62	LN	1
	101LPM3035/3	31	36	67	LP	1
	101LPM3035/4	31	36	67	LN	1
	101LPM3040/3	31	41	72	LP	1
	101LPM3040/4	31	41	72	LN	1
	101LPM3535/3	36	36	72	LP	1
	101LPM3535/4	36	36	72	LN	1
	101LPM4030/3	41	31	72	LP	1
	101LPM4030/4	41	31	72	LN	1
	101LPM3045/3	31	46	77	LP	1
	101LPM3045/4	31	46	77	LN	1
	101LPM3050/3	31	51	82	LP	1
	101LPM3050/4	31	51	82	LN	1
	101LPM4040/3	41	41	82	LP	1
	101LPM4040/4	41	41	82	LN	1
	101LPM3055/3	31	56	87	LP	1
	101LPM3055/4	31	56	87	LN	1
	101LPM3550/3	36	51	87	LP	1
	101LPM3550/4	36	51	87	LN	1
	101LPM4045/3	41	46	87	LP	1
	101LPM4045/4	41	46	87	LN	1
	101LPM3060/3	31	61	92	LP	1
	101LPM3060/4	31	61	92	LN	1
	101LPM4050/3	41	51	92	LP	1
	101LPM4050/4	41	51	92	LN	1
	101LPM3065/3	31	66	97	LP	1
	101LPM3065/4	31	66	97	LN	1
	101LPM3070/3	31	71	102	LP	1
	101LPM3070/4	31	71	102	LN	1
<ul style="list-style-type: none"> Demi cylindre 	101L3010/3	31	11	42	LP	1
	101L3010/4	31	11	42	LN	1
	101L3510/3	36	11	47	LP	1
	101L3510/4	36	11	47	LN	1
	101L4010/3	41	11	52	LP	1
	101L4010/4	41	11	52	LN	1
	101L4510/3	46	11	57	LP	1
	101L4510/4	46	11	57	LN	1
	101L5010/3	51	11	62	LP	1
	101L5010/4	51	11	62	LN	1
101L5510/3	56	11	67	LP	1	
101L5510/4	56	11	67	LN	1	
101L6010/3	61	11	72	LP	1	
101L6010/4	61	11	72	LN	1	

CYLINDRE EUROPÉEN NORMAL
SÉRIE 100L (5982) PANNETON LONG

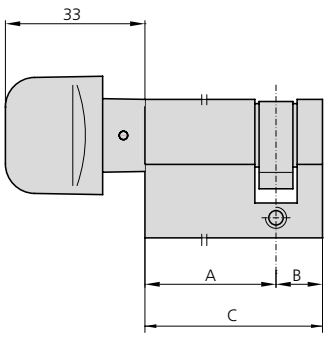
DESCRIPTION	RÉF.	DIMENSIONS			FINITIONS	PIÈCES
		A	B	C		
<ul style="list-style-type: none"> Demi cylindre avec bouton 	100LPM3010/3	31	11	42	LP	1
	100LPM3010/4	31	11	42	LN	1
	100LPM3510/3	36	11	47	LP	1
	100LPM3510/4	36	11	47	LN	1
	100LPM4010/3	41	11	52	LP	1
	100LPM4010/4	41	11	52	LN	1
	100LPM4510/3	46	11	57	LP	1
	100LPM4510/4	46	11	57	LN	1
	100LPM5010/3	51	11	62	LP	1
	100LPM5010/4	51	11	62	LN	1
	100LPM5510/3	56	11	67	LP	1
	100LPM5510/4	56	11	67	LN	1
	100LPM6010/3	61	11	72	LP	1
	100LPM6010/4	61	11	72	LN	1

- Demi cylindre
- Triangle d'un côté

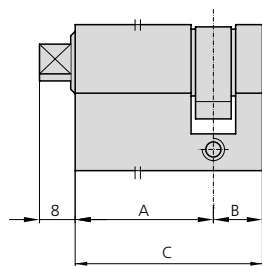

100LPT3010/3	31	11	42	LP	1
100LPT3010/4	31	11	42	LN	1

- Cylindre double
- Clé d'un côté et triangle de l'autre

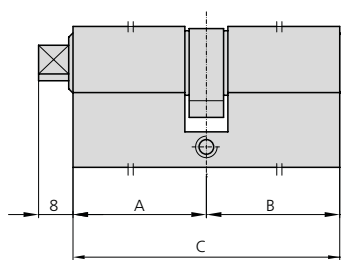

101LPT3030/3	31	31	62	LP	1
101LPT3030/4	31	31	62	LN	1
101LPT3040/3	31	41	72	LP	1
101LPT3040/4	31	41	72	LN	1
101LPT3050/3	31	51	82	LP	1
101LPT3050/4	31	51	82	LN	1

- Cylindre double
- Triangle d'un côté et bouton de l'autre

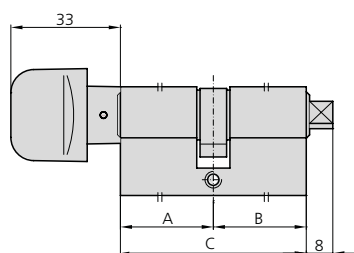

100LPM30T30/3	31	31	62	LP	1
100LPM30T30/4	31	31	62	LN	1
100LPM35T35/3	36	36	72	LP	1
100LPM35T35/4	36	36	72	LN	1
100LPM40T30/3	41	31	72	LP	1
100LPM40T30/4	41	31	72	LN	1
100LPM40T40/3	41	41	82	LP	1
100LPM40T40/4	41	41	82	LN	1
100LPM35T50/3	36	51	87	LP	1
100LPM35T50/4	36	51	87	LN	1