

PORTES BATTANTES

PÊNE DORMANT BASCULANT ENTRE-AXES 92 mm.

SÉRIE 194

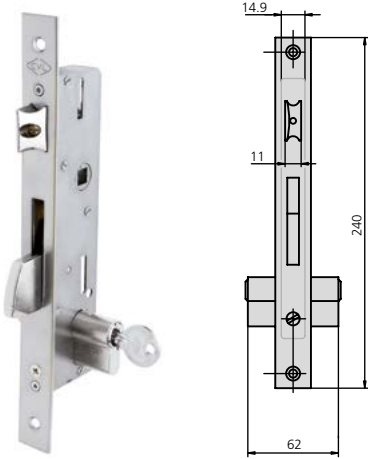

CARACTÉRISTIQUES

- Têtière inox plate de 22 mm ou 24 mm ou en "U" 24,5x6 mm
- Pêne 1/2 tour réversible de 11 mm
- Pêne 1/2 tour réglable, sauf sur axe de 25 mm
- Boîtier fermé de 15 mm
- Carré de 8 mm.
- 2 cache-cylindre réf. ES1984
- Vis de fixation de cylindre.

ACCESSOIRES EN OPTION

- Gamme complète de gâches
- Gamme complète de cylindres
- Cache cylindre de sécurité à vis transversantes BT1296
- Fouillot de condamnation rapporté

DESCRIPTION	RÉF.	DIMENSIONS		PANNETON	FINITIONS		PIÈCES	
		B	A		TÊTIÈRE	CYLINDRE		

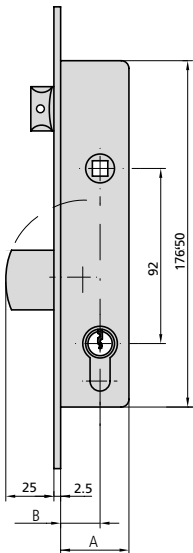

- Pêne demi-tour et pêne dormant
- Cylindre à panneton long 5982/2525/4

Gâches en option

Option gâches électriques

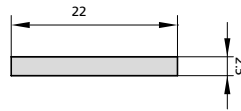

194/25/6	22	37	15	Al	CN	1	20
194/30/6	27	42	15	Al	CN	1	20
194/35/6	32	47	15	Al	CN	1	20

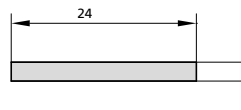

194/25/6AN	22	37	15	Al	CN	1	20
194/30/6AN	27	42	15	Al	CN	1	20
194/35/6AN	32	47	15	Al	CN	1	20

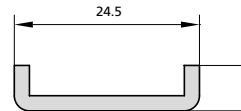

194/25/6U	18	33	15	Al U	CN	1	20
194/30/6U	23	38	15	Al U	CN	1	20
194/35/6U	28	43	15	Al U	CN	1	20

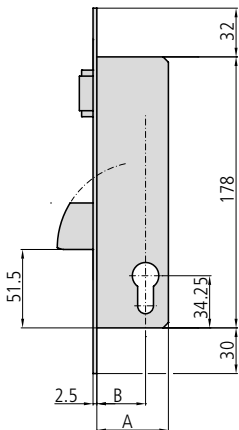

- Rouleau réglable et pêne dormant.
- Cylindre non inclus

Gâches en option



194RV25/6	22	37	15	Al	CN	1	20
194RV30/6	27	42	15	Al	CN	1	20
194RV35/6	32	47	15	Al	CN	1	20

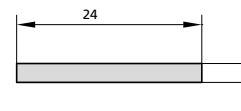

194RV25/6AN	22	37	15	Al	CN	1	20
194RV30/6AN	27	42	15	Al	CN	1	20
194RV35/6AN	32	47	15	Al	CN	1	20

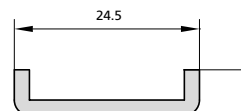

194RV25/6U	18	33	15	Al U	CN	1	20
194RV30/6U	23	38	15	Al U	CN	1	20
194RV35/6U	28	43	15	Al U	CN	1	20